

X3

Characteristics	<ul style="list-style-type: none"> ■ 8 mm creepage and clearance distance to the actuator ■ long mechanical and electrical life ■ solder, faston and PCB terminal ■ compliant to glow wire requirements IEC 60335-1, 4. ed.
Rating	250 VAC, 21 A max.
Dimensions (mm)	27,8 × 15,9 × 10,3
Actuator	<ul style="list-style-type: none"> ■ plunger ■ straight lever ■ simulated roller levers ■ roller levers
Approvals	UL, cUL, CSA, ENEC, CQC

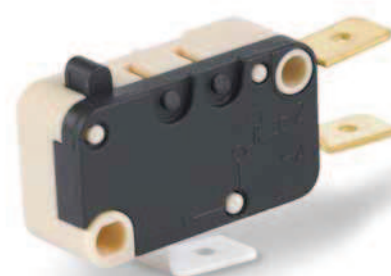

Preferred Range

Ordering Reference	Actuating Force		Operating pos.		Terminal	Circuit	Actuator	Contacts	Electrical rating	
	(N)	(ozf)	(mm)	(Inch)					ENEC	UL/CSA
X3M302N2KA	1,60	5,55	14,7	0,58	Faston	CO	Plunger	Ag/AgNi10	16 (6) A	20,5 A
X3M302N2NAJ32	0,88	3,15	15,6	0,59	Faston	CO	Plain lever	Ag/AgNi10	16 (6) A	20,5 A
X3M302N2NAJ62	0,57	2,05	14,8	0,58	Faston	CO	Plain lever	Ag/AgNi10	16 (6) A	20,5 A
X3M302N2NAT02	2,00	7,19	20,2	0,80	Faston	CO	Roller lever	Ag/AgNi10	16 (6) A	20,5 A
X3M303N2KA	1,60	5,73	14,7	0,58	Solder	CO	Plunger	Ag/AgNi10	16 (6) A	20,5 A
X3M306N2KA	1,60	5,73	14,7	0,58	Faston	CO	Plunger	Ag/AgNi10	16 (6) A	20,5 A
X3C302N2LB	0,80	2,88	14,7	0,58	Faston	CO	Plunger	Ag/AgNi10	10 (3) A	12 A
X3C302N2LBJ32	0,35	1,26	15,0	0,59	Faston	CO	Plain lever	Ag/AgNi10	10 (3) A	12 A
X3C303N2LB	0,80	2,88	14,7	0,58	Solder	CO	Plunger	Ag/AgNi10	10 (3) A	12 A
X3C306N2LB	0,80	2,88	14,7	0,58	Faston	CO	Plunger	Ag/AgNi10	10 (3) A	12 A
X3L302N6DD	1,50	5,40	14,7	0,58	Faston	CO	Plunger	Ag/AgCdO	21 (8) A	21 A
X3L303N6DD	1,50	5,40	14,7	0,58	Solder	CO	Plunger	Ag/AgCdO	21 (8) A	21 A

Specifications

Housing	Thermoplastic
Plunger	Thermoplastic
Mechanism	Snap-action, single pole beryllium bronze blade mechanism with wiping contacts
Contact carrier	Brass
Contacts	Fine silver (Ag), silver nickel (AgNi10), gold-plated (Au), silver cadmium oxide (AgCd0)
Terminals	Solder, Faston and RAST 5 terminals
Temperature range °C	Between -40°C and +125°C
Mechanical life	minimum cycles X3L: 105/ X3M: 106/X3C: 2 · 10 ⁶ (Actuation: sinusoidal and maximum up to 80% of the overtravel)
Protection	Enclosure IP40
Mounting	Side mounting via mounting holes
Actuators	Stainless steel (lever)

Circuit diagram

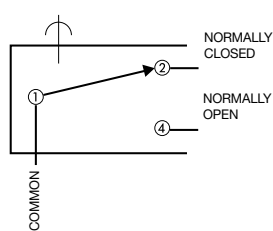

Actuating force/travel

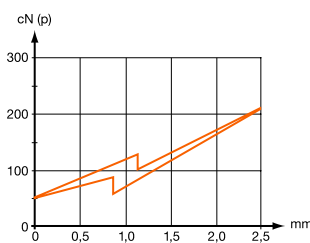

Contact force/travel

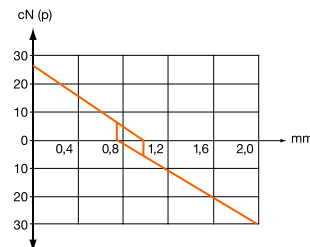

Dimensions

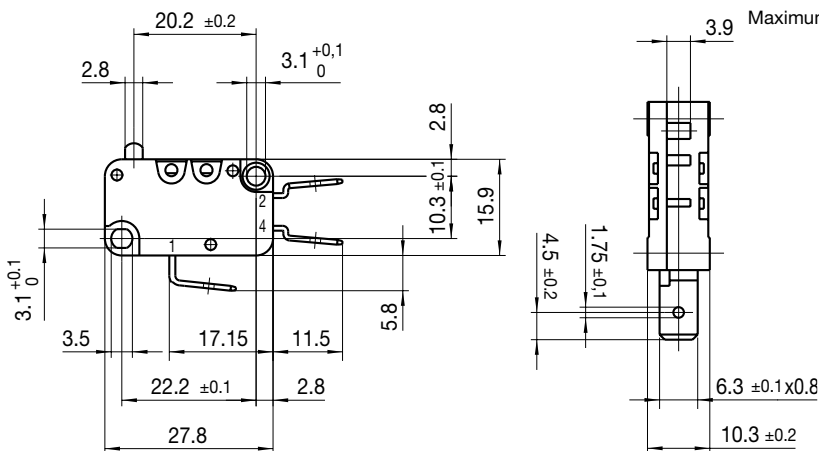

Maximum DC rating

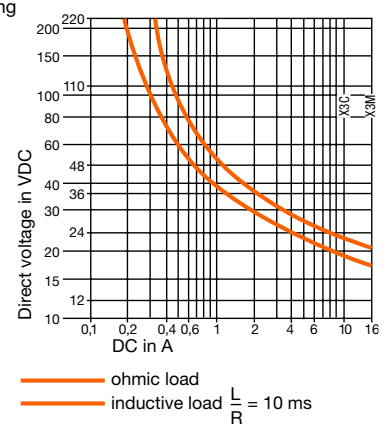

Recommended maximum electrical ratings

	Voltage (VAC)	Resistive load (A)	Motor load (A)	Approvals ENEC (A)		Approvals UL (VAC)	Approvals UL (A)		Motor load (HP)
				(A)	(VAC)		(A)	(VAC)	
X3M	250	16	6	16 (6)	5E4	250	20,5	250	1½ HP
X3C	250	10	3	10 (3)	5E4	250	20,5	125	½ HP
							12	250	¼ HP
X3L	250	21	8	21 (8)	1E4	250	21	250	2 HP
							21	125	1 HP

Current breaking capacities in the tables refer to Ag/AgNi10 contacts with the exception of X3L Ag/AgCd0

Operating Characteristics

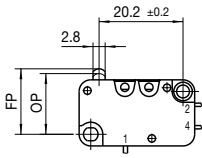
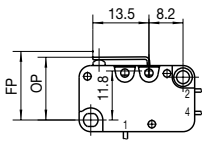
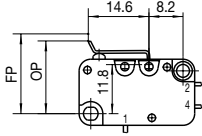
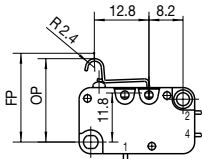
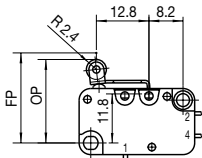
Actuator	Reference	Actuating Force		Release Force		Free FP Position		Operating OP Position		Movement Differential		Full overtravel Position		
		Maximum (N)	(ozf)	Minimum (N)	(ozf)	Maximum (mm)	(in)	(mm)	(in)	Maximum (mm)	(in)	Maximum (mm)	(in)	
	X3C	0,80	2,88	0,050	0,179	15,75	0,620	14,7	$\left. \begin{matrix} 0,58 \\ +0,2 \\ -0,4 \end{matrix} \right\} 0,58$	$\left. \begin{matrix} +0,008 \\ -0,016 \end{matrix} \right\} 0,25$	0,25	0,009	13,2	0,519
	X3M	1,60	5,76	0,200	0,719	15,75	0,620	14,7						
	X3L	1,50	5,40	0,150	0,540	15,75	0,620	14,7						
	X3C ..	0,80	2,88	0,045	0,162	16,50	0,649	15,1 ± 0,5	0,59 ± 0,019	0,35	0,014	14,0	0,550	
	X3M ..	2,00	7,19	0,180	0,647	16,50	0,649	15,1 ± 0,5	0,59 ± 0,019	0,35	0,014	14,0	0,550	
	X3L ..	1,90	6,83	0,140	0,500	16,50	0,649	15,1 ± 0,5	0,59 ± 0,019	0,35	0,014	14,0	0,550	
Width of lever 7,0 mm/0,28 in – also available with width 4 mm/0,16 in														
	X3C ..	0,65	2,34	0,045	0,162	19,20	0,755	17,5 ± 0,7	0,69 ± 0,028	0,35	0,014	16,4	0,646	
	X3M ..	1,65	5,93	0,160	0,576	19,20	0,755	17,5 ± 0,7	0,69 ± 0,028	0,35	0,014	16,4	0,646	
	X3L ..	1,55	5,58	0,140	0,500	19,20	0,755	17,5 ± 0,7	0,69 ± 0,028	0,35	0,014	16,4	0,646	
Width of lever 7,0 mm/0,28 in														
	X3C ..	0,80	2,88	0,045	0,162	21,80	0,858	20,5 ± 0,6	0,81 ± 0,024	0,35	0,014	19,5	0,768	
	X3M ..	2,00	7,19	0,190	0,683	21,80	0,858	20,5 ± 0,6	0,81 ± 0,024	0,35	0,014	19,5	0,768	
	X3L ..	1,90	6,83	0,140	0,500	21,80	0,858	20,5 ± 0,6	0,81 ± 0,024	0,35	0,014	19,5	0,768	
Width of lever 7,0 mm/0,28 in														
	X3C ..	0,80	2,88	0,045	0,162	21,80	0,858	20,2 ± 0,7	0,79 ± 0,028	0,35	0,014	19,3	0,760	
	X3M ..	2,00	7,19	0,190	0,683	21,80	0,858	20,2 ± 0,7	0,79 ± 0,028	0,35	0,014	19,3	0,760	
	X3L ..	1,90	6,83	0,140	0,500	21,80	0,858	20,2 ± 0,7	0,79 ± 0,028	0,35	0,014	19,3	0,760	
Width of roller 6,6 mm/0,26 in														

Ordering Reference

Basic type	X3	Microswitch according to DIN 41635, Design A	Example: X3	M	3	02	K	2	A	A	J0	2
Operating force	M	Standard force 1										
	L	Standard force 2										
	C	Low force										
Circuit diagram	3	Change-over (CO)										
	4	Normally closed (NC)										
	5	Normally open (NO)										
Terminals	02	Plug terminal 6,3 × 0,8 mm	13	PCB-terminal, Formed to lid								
	03	Solder terminal	14	PCB-terminal, Formed to base								
	06	Plug terminal 4,8 × 0,5 mm	15	Plug terminal RAST 5 6,3 × 0,8 mm								
	10	Plug terminal 4,8 × 0,8 mm										
	12	Solder terminal, short										
Body	N	PA66GF25										
Contacts materials	2	Silver/AgNi10										
	6	AgCd0										
	8	Gold plated										
UL/C-UL ratings	A	20,5 A, 125/250 VAC	M	6 A, 125/250 VAC								
		15 A, 125/250 VAC, 100'000 cy.		1/8 HP, 250 VAC, 1/8 HP, 125 VAC								
		1 1/2 HP, 250 VAC, 1/2 HP, 125 VAC	N	No approvals								
	D	21 A, 125/250 VAC	P	20,5 A, 125/250 VAC								
		2 HP, 250 VAC, 1 HP, 125 VAC		1 1/2 HP, 250 VAC, 1/2 HP, 125 VAC								
	E	21 A, 125/250 VAC	Q	1/4 HP, 250 VDC, 1/2 HP, 125 VDC								
		15 A, 125/250 VAC, 100'000 cy.		12 A, 125/250 VAC								
K	2 HP, 250 VAC, 1 HP, 125 VAC	R	1/8 HP, 250 VAC, 1/8 HP, 125 VAC									
	20,5 A, 125/250 VAC		1/4 A, 250 VDC, 1/2 A, 125 VDC									
L	1 1/2 HP, 250 VAC, 1/2 HP, 125 VAC		6 A, 125/250 VAC									
	12 A, 125/250 VAC		1/8 HP, 250 VAC, 1/8 HP, 125 VAC									
		1/8 HP, 250 VAC, 1/8 HP, 125 VAC		1/4 A, 250 VDC, 1/2 A, 125 VDC								
EN/IEC ratings	A	16 (6) A, 250 V~ 5E4 T125 μ approved										
	B	10 (3) A, 250 V~ 5E4 T125 μ approved										
	C	6 (3) A, 250 V~ 5E4 T125 μ approved										
	D	21 (8) A, 250 V~ 1E4 T105 μ approved										
	M	no approvals										
Type of actuator		No symbol, without lever										
	J0 to J9	Straight lever (width 7 mm)										
	L0 to L9	Simulated roller lever										
	M0 to M9	Customer specified lever (KV)										
	P0 to P9	Straight lever (width 4 mm)										
	T0 to T9	Roller lever										
	Other actuators and lengths available											
Actuator position		No symbol, without lever										
	2	Rear lever										
	4	Front lever										